

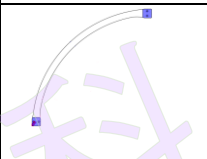









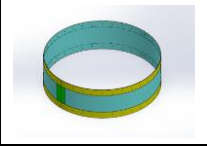

A7 PARTS LIAT

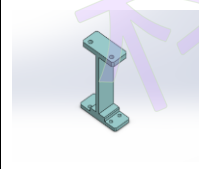
OEM	品名 Product name	圖號 /Drawing number	圖片/Photo	材質/ Material	備註/Note
	A7 spindle INNER				1.加熱片 PH0045-A1-04 數量1 2.右電極腳 PH0045-A1-01 數量:1 3.電極壓版 PH0045-A-03 數量:2 4.左電極腳 PH0045-A-05 數量:1 5.螺絲 PH0045-A1-05 數量:4
615-04562-000-P02	A7 Outer(一組四片)	PH0033-A		RE	
	A7 Middle	PH0032-B		Tungsten	
	A7 Moly ring	PM0275-A		Moly	
615-02770	SCREW (middle Outer)	PT0074-A		Tungsten+La	
615-04525-000-P01	Outer Support 外圈加熱絲支撐絲	PT0075-A		Tungsten	
615-04524-000-P01	Middle Support (2)	PT0076-A		Tungsten	
615-04522-000-P01	Middle Support (1) 小中圈加熱絲支撐絲	PT0077-A		Tungsten	
625-00888-000-P01	加熱片支撐絲安裝陶瓷	PBN0052-A		BN	
615-04852-000-P01	Middle Support WIRE(2)	PT0080-A		Tungsten	
615-02757-000-P02	A7 外圈加強絲	PT0089-A		Tungsten	

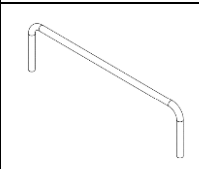
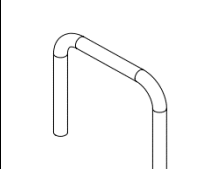
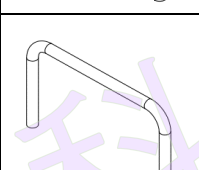
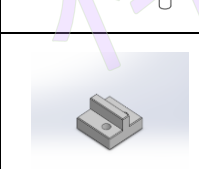
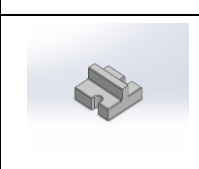
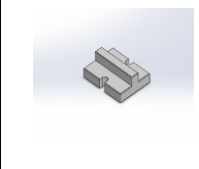
713-00010-220-000	電極柱 O Ring ID1.359" x W0.139"	PD0080-A		Viton	
615-04537-000-P01	外圈加熱片壓板-25 25x26x3t	PT0084-A		Tungsten or Moly	
615-04536-000-P01	外圈加熱片壓板-24 24x24x3t	PT0083-A		Tungsten or Moly	
615-03960-000-P01	外圈加熱片壓板 26x24x3t	PT0085-A		Tungsten or Moly	
615-04523-000-P01	小中圈加熱片支撐絲-2 21W x 24L	PT0090-A		Tungsten	
615-02770-000-P02	鎢螺絲 M4 x 12L 有兩點	PT0086-A		Tungsten	
615-04526-000-P01	中圈壓板	PT0088-A		Tungsten	
615-02767-000	固定電極螺絲 M4 x 8L 有兩點	PT0087-A		Tungsten or Moly	
615-04528-000-P01	大中圈螺釘夾板	PT0082-A		Tungsten or Moly	
615-04542-000-P01	外圈螺釘夾板 (加熱絲固定塊)	PT0081-A		Tungsten or Moly	
615-02771-000	固定電極支架塊螺絲 M5X25,480 HEATER	PM0280-A		Tungsten or Moly	
615-02771-000-P02	外圈螺桿M5X25,480 HEATER			Tungsten or Moly	
615-04540-000	外圈加熱絲支架塊 type2	PM0279-A		Moly	

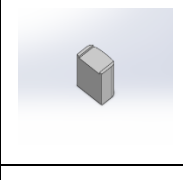
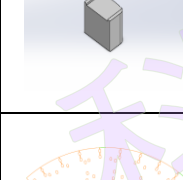
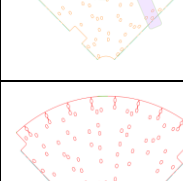
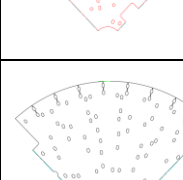
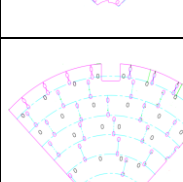
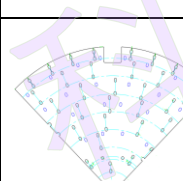
615-05241-000-P02	固定壓塊螺絲 M4x12L	PT0074-A		Tungsten or Moly	
615-04541-000	外圈加熱片支架塊 type3	PM0278-A		Tungsten or Moly	
540-032000-000	Collector	PS0096-A		SUS	
615-06784-000-P01	MID2 CORNER SUPPORT WIRE	PT0100-A		W or WRE(5%)	
615-06780-000-P01	MIDDLE SUPPORT WIRE 3	PT0101-A		W or WRE(5%)	
615-04852-000-P01	MIDDLE SUPPORT WIRE 2	PT0102-A		W or WRE(5%)	
625-01488-000-P01	隔離陶瓷	PC0103-A		Ceramic	
625-01489-000-P01	隔離陶瓷	PC0104-A		Ceramic	
625-01764-000-P02	中外圈大陶瓷	PC0105-A		Ceramic	
625-01378-000-P01	電極陶瓷	PC0106-A		Ceramic	
625-00886-000-P01	外圈電極柱絕緣陶瓷	PC0107-A		Ceramic	

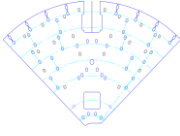
625-01665-000-P02	間隔陶瓷 14mm	PC0108-A		Ceramic	
625-01667-000-P02	間隔陶瓷 13.5mm	PC0109-A		Ceramic	
625-01668-000-P02	間隔陶瓷 14.5mm	PC0110-A		Ceramic	
625-01669-000-P02	間隔陶瓷 12.3mm	PC0111-A		Ceramic	
615-0451-000-P02	散熱片0.5	PM0294-A		Moly	
615-0452-000-P02	散熱片0.5	PM0295-A		Moly	
615-0453-000-P02	散熱片0.5	PM0296-A		Moly	
615-0454-000-P02	散熱片0.5	PM0297-A		Moly	
615-04497-000-P02	散熱片1T 04497	PT0094-A		Tungsten	
615-04498-000-P02	散熱片1T 04998	PT0095-A		Tungsten	
615-04499-000-P02	散熱片1T 04499	PT0096-A		Tungsten	

615-04500-000-P02	散熱片1T 04500	PT0097-A		Tungsten	
615-06471-000-P01	钼环隔离支撑丝	PT0111-A	<p>PT0111 A</p> 	Tungsten	

天祺科技